

Group: Controls

Part Number: IM 1005

Date: March 2012

Supercedes: IM 1005-1

## **MicroTech® III Remote User Interface**

**Applied Rooftop Models: RPE, RDE, RPS, RDT, RFS, RDS and RAH**

**Self-Contained Models: SWP and SWT**

**Daikin Rebel™ Model DPS**

**Maverick II™ Model MPS**

**Pathfinder™ Chiller, Model AWS**

**Air-Cooled Scroll Chiller, Model AGZ-D**



# Contents

Figures .....	2
Revision History .....	3
Limited Warranty.....	3
<b>General Information .....</b>	<b>4</b>
Hazard Identification Messages.....	4
Description .....	5
Component Data .....	5
Physical data .....	5
<b>Installation.....</b>	<b>9</b>
Contents of the MicroTech III Remote User Interface Kit .....	9
Installing the MicroTech III Remote User Interface.....	9
<b>Using the MicroTech III Remote User Interface.....</b>	<b>13</b>
Introduction .....	13
Setting up the Remote User Interface for Use.....	13
Navigating the Keypad/Display .....	15
Keypad/Display Overview.....	15
Parts and Service .....	16
Parts List.....	16

# Figures

Figure 1. Physical Dimensions	5
Figure 2. Interface Details	7
Figure 3. Direct Connect (RS-485) Interface Details.....	8
Figure 4. Removing the Cover of Remote User Interface.....	10
Figure 5. Terminal Connection Options from the Remote User Interface to Unit Controller.....	10
Figure 6. Wiring Connections – Daisy Chain using twisted pair cable.....	11
Figure 7. Wiring Connections – RS-485 Direct Connection Location.....	11
Figure 8. Wiring Connections – RS-485 Screw Connection*.....	11
Figure 9. Wall and Surface Wiring Connections .....	12
Figure 10. Remote User Interface Main Features .....	13
Figure 11. Main Screen Options .....	14
Figure 12. HMI Settings Screen Details .....	14
Figure 13. Controller List Screen Details .....	15
Figure 14. Information Screen: Downloading Objects .....	15

## Revision History

IM 1005	January 2010	Initial release
IM 1005-1	September 2010	Added AGZ-D Model
IM 1005-2	March 2012	Added Rebel to cover. Updated Daikin logo. Updated figure 3 with labels and more visible connector cables.

## Limited Warranty

Consult your local Daikin Representative for warranty details. Refer to Form 933-43285Y. To find your local Daikin Representative, go to [www.DaikinApplied.com](http://www.DaikinApplied.com).

### Notice

Copyright © 2013 Daikin Applied, Minneapolis MN. All rights reserved throughout the world. Daikin reserves the right to change any information contained herein without prior notice. The user is responsible for determining whether this software is appropriate for his or her application.

®™ The following are tradenames or registered trademarks of their respective companies; McQuay, Rebel, Daikin, Maverick, Pathfinder, and MicroTech III from Daikin.

# General Information

---

This manual contains the information you need to field install and operate the remote user interface for use with the MicroTech III Applied Air (Rooftop, Self-Contained, Rebel, and Maverick II), Pathfinder, and AGZ-D Air-Cooled Scroll Chiller units.

## Hazard Identification Messages

### DANGER

Dangers indicate a hazardous situation which will result in death or serious injury if not avoided.

### WARNING

Warnings indicate potentially hazardous situations, which can result in property damage, severe personal injury, or death if not avoided.

### CAUTION

Cautions indicate potentially hazardous situations, which can result in personal injury or equipment damage if not avoided.

### WARNING

**Electric shock hazard. Can cause personal injury or equipment damage.**

This equipment must be properly grounded. Connections and service to the MicroTech III Unit Controller must be performed only by personnel knowledgeable in the operation of the equipment being controlled.

### CAUTION

**Static sensitive components. Can cause equipment damage.**

Discharge any static electrical charge by touching the bare metal inside the control panel before performing any service work. Never unplug cables, circuit board terminal blocks, or power plugs while power is applied to the panel.

### NOTICE

This equipment generates, uses and can radiate radio frequency energy and, if not installed and used in accordance with this instruction manual, may cause interference to radio communications. It has been tested and found to comply with the limits for a Class A digital device, pursuant to part 15 of the FCC rules. These limits are designed to provide reasonable protection against harmful interference when the equipment is operated in a commercial environment. Operation of this equipment in a residential area is likely to cause harmful interference in which case the user will be required to correct the interference at his or her own expense. Daikin disclaims any liability resulting from any interference or for the correction thereof.

# Description

The remote user interface is designed for display, system configuration, set-up, and management of MicroTech III unit controllers (Rooftop, Self-Contained, Rebel, Maverick II, Pathfinder, or AGZ-D Air-Cooled Chillers).

In addition to the unit-mounted controller keypad/display, MicroTech III unit controls units can be equipped with a remote user interface that handles up to eight units per interface. The remote user interface provides access to unit diagnostics and control adjustments similar to the unit-mounted controller. Features include:

- Push-and-roll navigation wheel with an 8-line by 30-character display format
- Operating conditions, system alarms, control parameters and schedules are monitored
- RS-485 or KNX interface for local or remote installation
- Power from controller, no additional power supply necessary
- Supports panel mounting and wall mounting
- Digital display of messages in English language

# Component Data

## Physical data

Figure 1 shows the details of the remote user interface hardware design. The overall physical layout includes:

- 144 x 96 x 26 mm size
- Plastic housing

Figure 1. Physical Dimensions

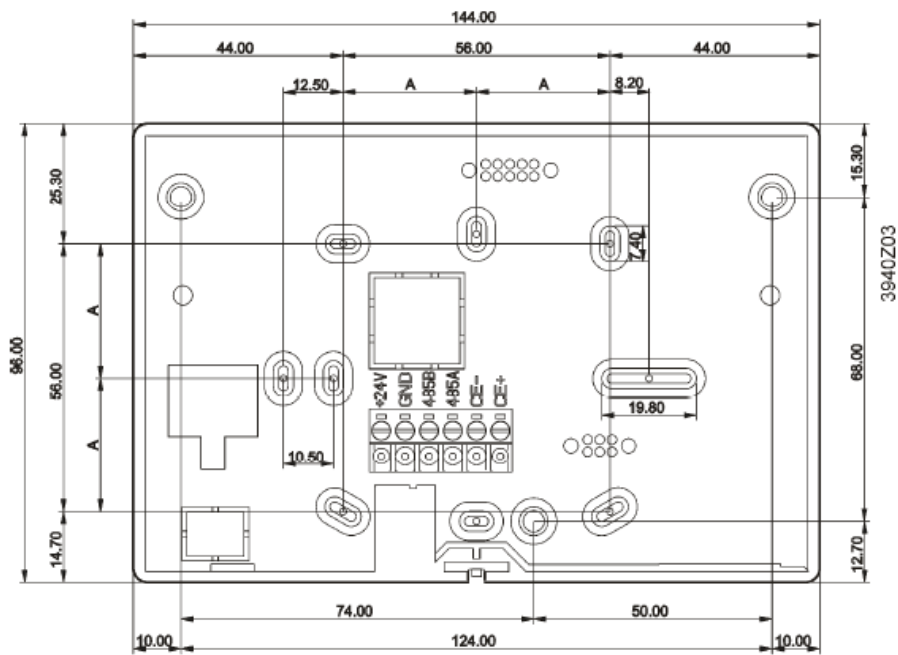

## Display

- LCD type FSTN
- Resolution Dot-matrix 96 X 208
- Backlight Blue or White, user selectable

## Environmental Conditions

- Operation IEC 721-3-3
- Temperature -40...+70 °C
- Restriction LCD -20...+60 °C
- Restriction Process-Bus -25...+70 °C
- Humidity < 90 % r.h (no condensation)
- Air pressure Min. 700 hPa, corresponding to max. 3,000 m above sea level

## Technical data

Figures 2 and 3 provide the details for the remote user interface bus connections using 1) either KNX or RS-485 cable for direct connection to a single unit using standard 8-wire twisted net cable, or 2) connection to one or more units using twisted pair cable.

Figure 2. Interface Details

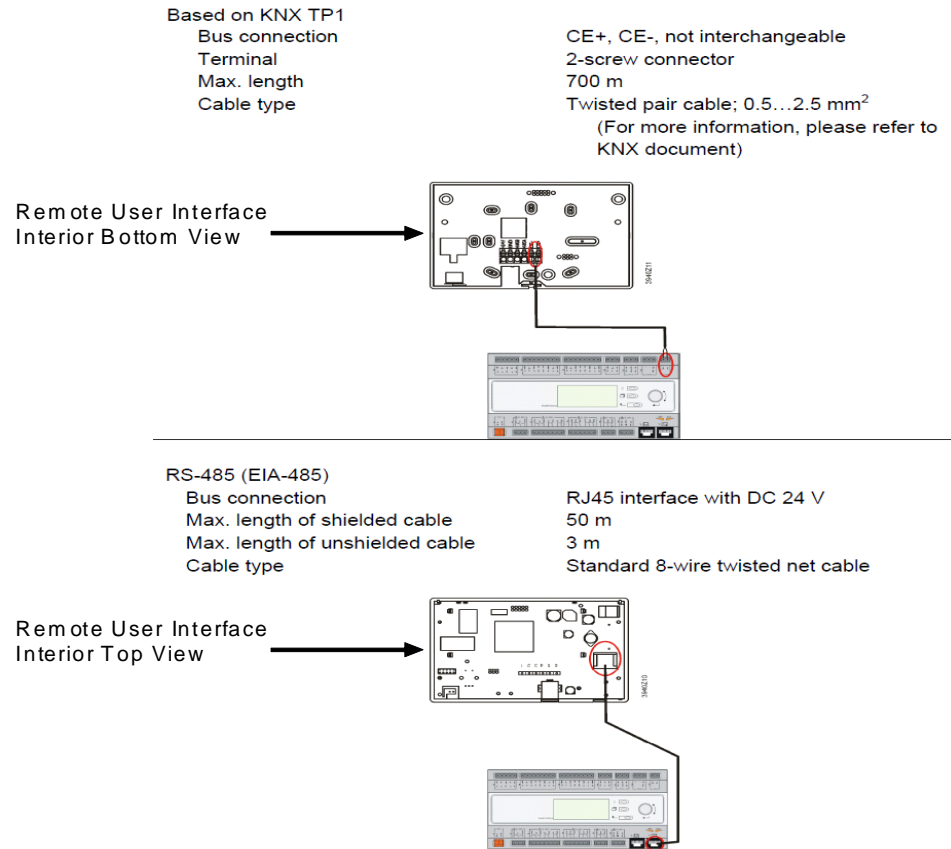
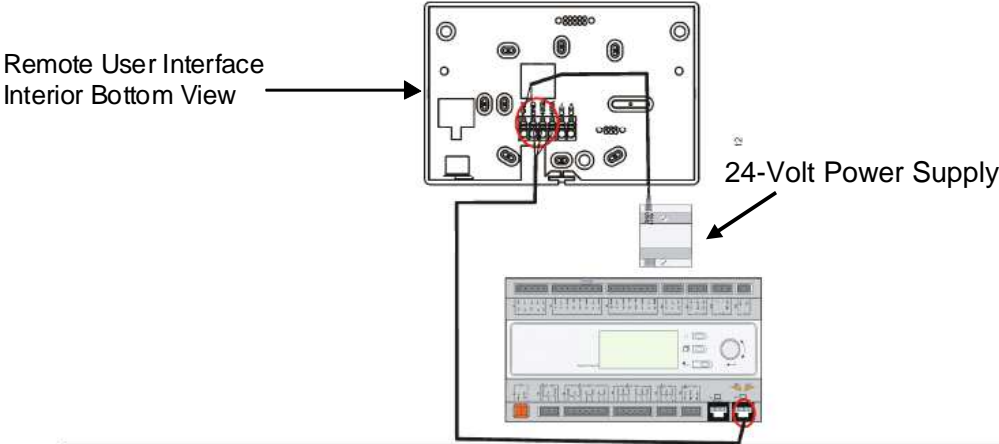

Figure 3. Direct Connect (RS-485) Interface Details

RS-485 Screw connection  
Bus connection  
Power connection  
Max. length  
Cable type

RS485A, RS485B, +24V  
+24V, GND  
1000 m  
Twisted pair shielded AWG





# Installation

---

The following section describes how to mount the remote user interface and connect it to one or more MicroTech III unit controllers.

## CAUTION

### **Electrostatic discharge hazard. Can cause equipment damage.**

This equipment contains sensitive electronic components that may be damaged by electrostatic discharge from your hands. Before you handle a communications module, you need to touch a grounded object, such as the metal enclosure, in order to discharge the electrostatic potential in your body.

## Contents of the MicroTech III Remote User Interface Kit

The following is the list of items included in the field-installed kit:

- The remote user interface plastic enclosure with 2 pin terminal connector (CE+ - CE-)
- IM 1005 installation manual

## WARNING

### **Electric shock hazard. Can cause personal injury or equipment damage.**

This equipment must be properly grounded. Connections and service to the MicroTech III Unit Controller must be performed only by personnel knowledgeable in the operation of the equipment being controlled.

## Installing the MicroTech III Remote User Interface

1. Remove plastic cover (see Figure 4).
2. Mount the Remote User Interface. The remote user interface can be either panel mounted or wall mounted (see Figure 5 for terminal connections for each of the mounting locations).
3. Connect the Remote User Interface to the MicroTech III unit controller. This can be done one of two different ways:
  - Direct connection to a single unit controller with an RS-485 direct connection. See Figure 7 for the connector location and Figure 8 for the pin-out description for the RS-485 connection. *Note that wiring requires a separate 24-Volt power supply.*
  - Daisy-chain connection to as many as eight units using a twisted pair wire connected to the CE + and CE – pins (see Figure 2 and Figure 6 for wiring details).
4. Cycle power to the unit(s) once the wiring of the remote user interface is complete.

---

**Note:** Downloading and communication using the twisted pair may be slower than for the RS-485 direct connection.

---

Figure 4. Removing the Cover of Remote User Interface

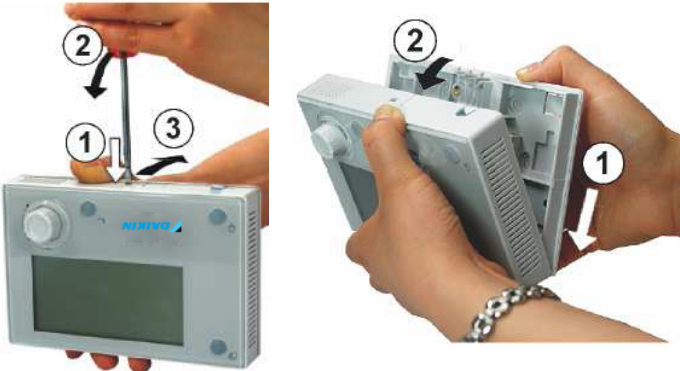

Figure 5. Terminal Connection Options from the Remote User Interface to Unit Controller

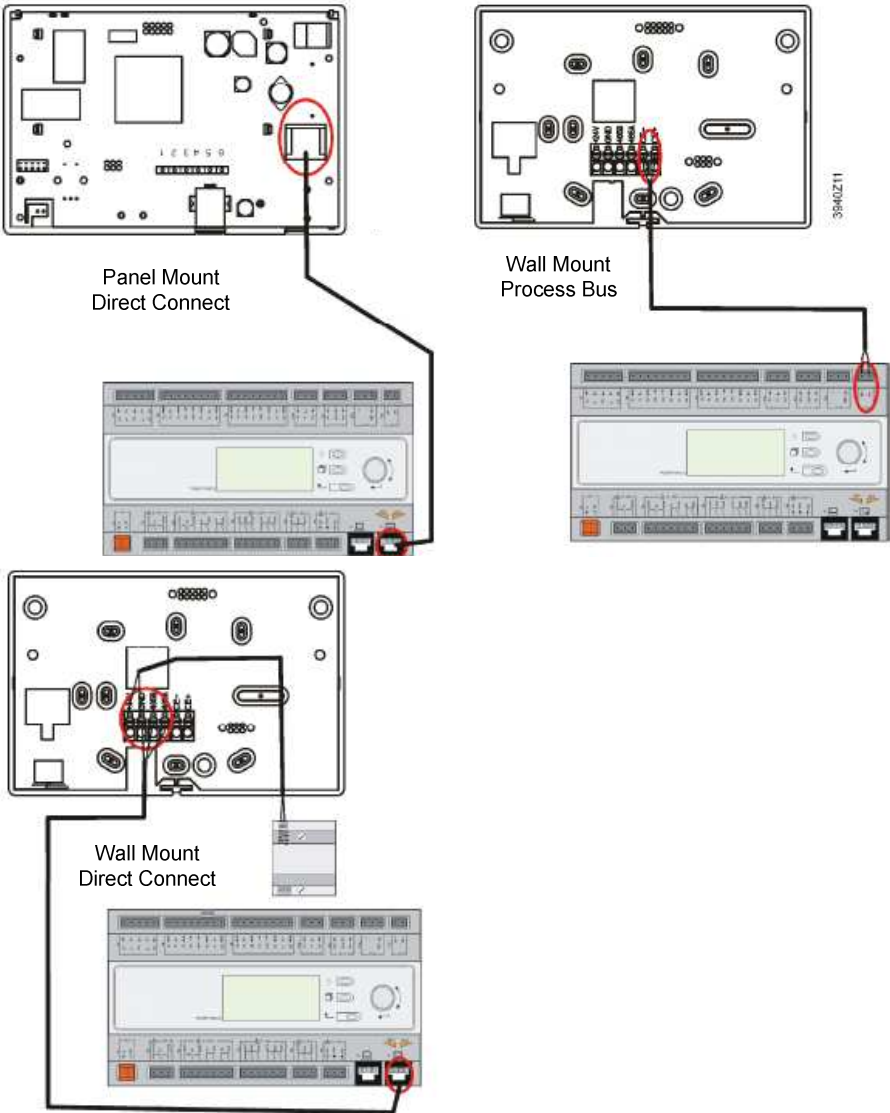

Figure 6. Wiring Connections – Daisy Chain using twisted pair cable

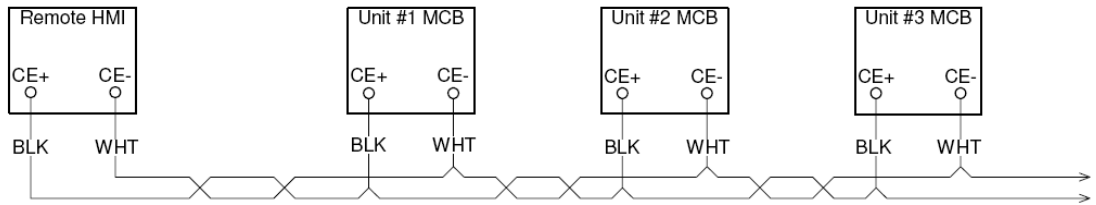

Figure 7. Wiring Connections – RS-485 Direct Connection Location

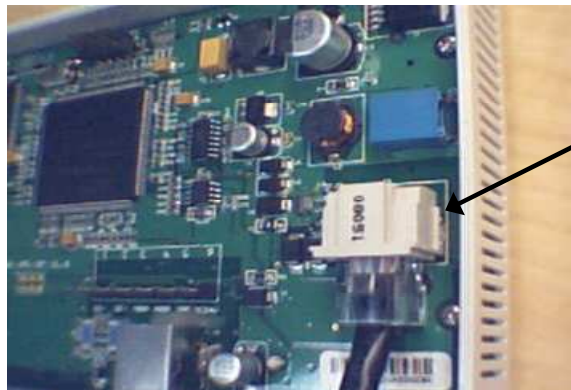
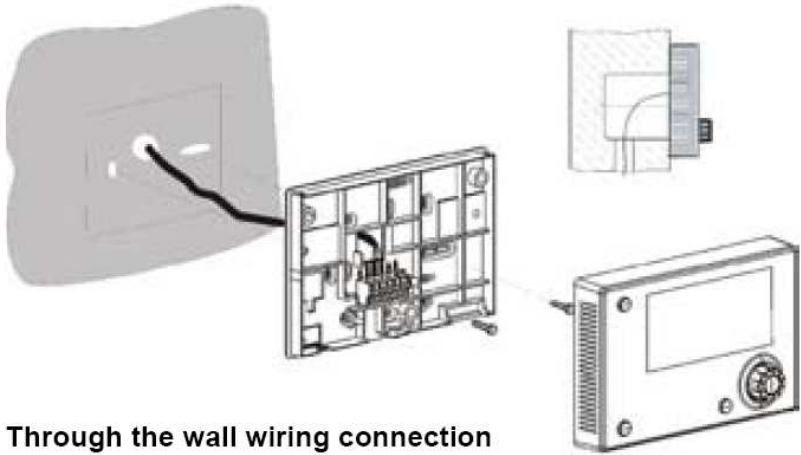

Figure 8. Wiring Connections – RS-485 Screw Connection\*

①		White/orange
②		Orange
③	485_A	White/green
④	GND	Blue
⑤		White/blue
⑥	485_B	Green
⑦		White/brown
⑧	+24 V	brown

\*Note that wiring requires a separate 24-Volt power supply.

Figure 9. Wall and Surface Wiring Connections



Through the wall wiring connection

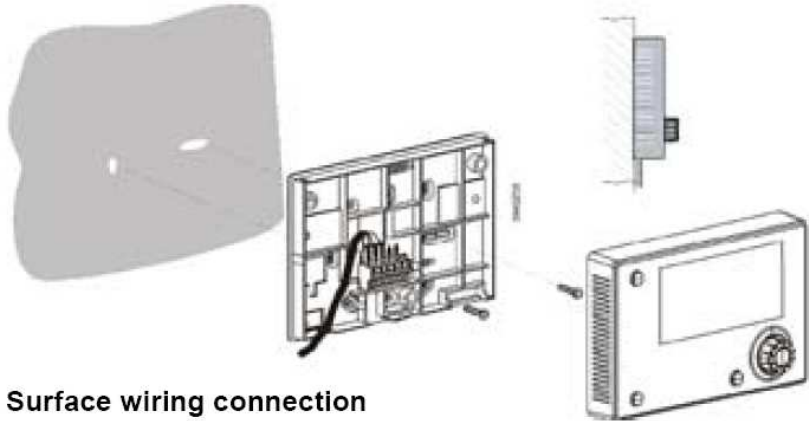

Surface wiring connection

# Using the MicroTech III Remote User Interface

---

## Introduction

The remote user Interface keypad/display consists of an 8-line by 30 character display, a “push and roll” navigation wheel, and three buttons: Alarm, Menu, and Back (see Figure 10). The navigation wheel is used to navigate between lines on a screen (page) and to increase and decrease changeable values when editing. Pressing the wheel acts as an Enter button. When the Back button is pressed, the display reverts back to the previously displayed page. When the Home button is pressed, the display reverts to the main page. When the Alarm button is pressed, the Alarm Lists menu is displayed.

The following section describes how to set up the remote user interface so that it can be used to display, configure, or change unit parameters. For instructions on how to use the remote user interface, refer to the applicable MicroTech III Unit Controller Operation Manual for a detailed description of chiller or rooftop sequence of operation and keypad menu structure (available on [www.DaikinApplied.com](http://www.DaikinApplied.com)).

Figure 10. Remote User Interface Main Features

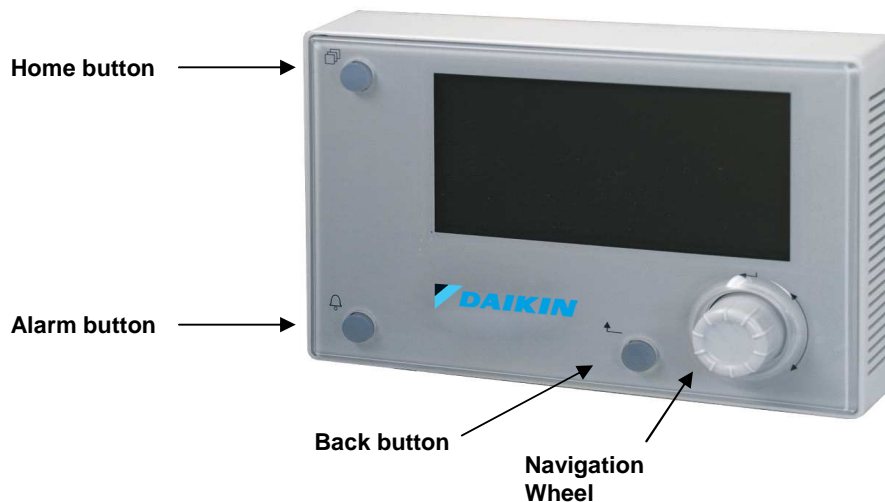

## Setting up the Remote User Interface for Use

Once the remote user interface has been installed, (see Installation section of this manual for instructions) it is then possible to configure user preferences and synchronize it with the main unit controller by following these steps:

1. Turn power on to the unit controller(s). Power to the Remote User Interface is provided automatically from the unit controller(s) through the RS-485 direct or twisted pair connection.
2. The main screen with HMI Settings and Controller List appears (see Figure 11).

---

**Note:** The main screen can be accessed at any time by pressing the Home button for several seconds.

---

Figure 11. Main Screen Options



3. Press the navigation wheel to select the HMI Settings menu, if desired. Use this menu to change options for backlight color, backlight turn off time, contrast, and brightness (see Figure 12).
4. Once HMI settings options are set, press the navigation wheel to select the Controller List screen.
  - The Controller List must automatically update each time the remote user interface is powered up so that information is synchronized from the main unit controller.
  - The Controller List screen displays the unit controller(s) connected to the remote user interface. This screen allows the user to select between units, if more than one unit is connected to the remote user interface (see Figure 13). **Note:** a single unit appears on the screen as a selection possibility if only one unit controller is connected to the remote user interface.
5. Turn the navigation wheel clockwise and then press down to select the desired unit.
  - The Information screen appears as the remote user interface performs a download sequence to import the necessary information from the main unit controller. A status bar appears on the Downloading the Objects screen to indicate that the download is in process (see Figure 14).
6. Once the first unit is complete, select additional unit controllers, if applicable. The download process is required for each unit controller connected to the remote user interface.

---

**Note:** The Downloading the Objects sequence generally takes a minute or less when connecting to a single unit with an RS-485 direct connection. However, the downloading sequence takes longer when using the twisted pair connection and/or additional units are connected.

---

7. When the download sequence is complete, the Main screen of the unit controller appears on the remote user interface display. At this point, it is now possible to access and adjust the same parameters that are available via the unit controller keypad/display. Refer to the applicable MicroTech III Unit Controller Operation Manual for the keypad menu structure and detailed description the unit controller sequence of operation (available on [www.DaikinApplied.com](http://www.DaikinApplied.com)).

Figure 12. HMI Settings Screen Details

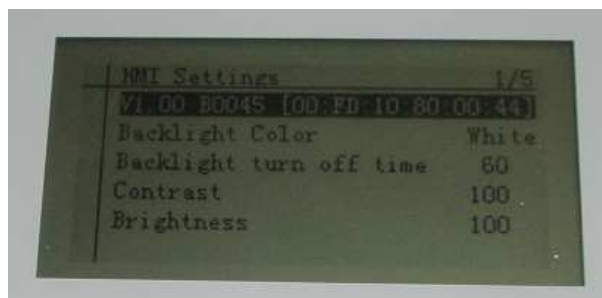

Figure 13. Controller List Screen Details

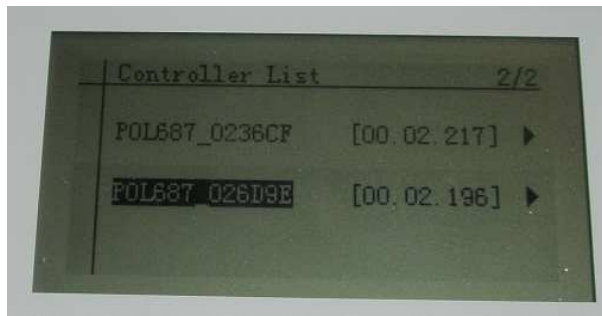
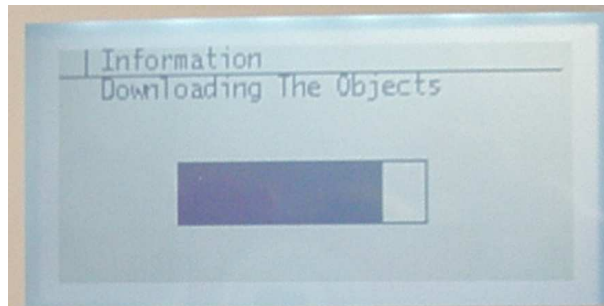

Figure 14. Information Screen: Downloading Objects



## Navigating the Keypad/Display

The following section provides a basic overview of the remote user interface features. Refer to the appropriate MicroTech III Unit Controller Operation Manual (available on [www.DaikinApplied.com](http://www.DaikinApplied.com)) for complete details on how to use the keypad/display to view and change parameters and also for the unit controller sequence of operation.

### Keypad/Display Overview

The first line on each page includes the page title and the line number to which the cursor is currently “pointing.” The line numbers are X/Y to indicate line number X of a total of Y lines for that page. The left most position of the title line includes an “up” arrow to indicate there are pages “above” the currently displayed items, a “down” arrow to indicate there are pages “below” the currently displayed items or an “up/down” arrow to indicate there are pages “above and below” the currently displayed page.

Each line on a page can contain status-only information or include changeable data fields. When a line contains status-only information and the cursor is on that line, all but the value field of that line is highlighted meaning the text is white with a black box around it. When the line contains a changeable value and the cursor is at that line, the entire line is highlighted. Each line on a page may also be defined as a “jump” line, meaning pushing the navigation wheel will cause a “jump” to a new page. An arrow is displayed to the far right of the line to indicate it is a “jump” line and the entire line is highlighted when the cursor is on that line.

---

**Note:** Only menus and items that are applicable to the specific unit configuration are displayed.

---

### Alarms

The Alarm Lists Menu includes active alarm and alarm log information. See the specific Operation Manual for your unit(s) to review available alarm options.

## Passwords

When the keypad/display is first accessed, the Home button is pressed, the Back button is pressed multiple times or if the keypad/display has been idle for the Password Timeout timer (default 10 minutes), and the display will show the “Main” page where the user can enter a password or continue without entering a password.

The three password levels available are Level 2, Level 4, and Level 6. Level 2 has the highest level of access.

---

**Note:** Alarms can be acknowledged without entering a password.

---

Complete information regarding the contents of each sub-menu is included in MicroTech III Unit Controller Operation Manual.

## Parts and Service

For additional assistance with the installation, configuration, or use of the remote user interface, contact one of the following product support groups:

Applied Air Customer Support: 763-553-5330

Chiller Technical Response Center: 877-349-7782

## Parts List

Contact the Parts department at 763-553-5451 for remote user interface replacement parts and accessories (see below for details).

Description	Part Number
MicroTech III Remote User Interface kit (kit includes remote user interface, 2 pin connector and Installation Manual)	193408001
Connectors, (utilizing CE+ CE- connection option)	193410302



This document contains the most current product information as of this printing. For the most current product information, please go to **[www.DaikinApplied.com](http://www.DaikinApplied.com)**. All equipment is sold pursuant to Daikin Standard Terms and Conditions of Sale and Limited Warranty.

Daikin Applied  
800.432.1342  
[www.DaikinApplied.com](http://www.DaikinApplied.com)